

Class Test Solution (HIGHWAY) 22-07-2017

Answer key

1.	(d)	16.	(b)	31.	(d)	46.	(c)	61.	(c)
2.	(b)	17.	(b)	32.	(b)	47.	(c)	62.	(b)
3.	(d)	18.	(a)	33.	(b)	48.	(b)	63.	(d)
4.	(b)	19.	(a)	34.	(c)	49.	(d)	64.	(d)
5.	(c)	20.	(c)	35.	(a)	50.	(d)	65.	(c)
6.	(d)	21.	(c)	36.	(a)	51.	(b)	66.	(d)
7.	(b)	22.	(c)	37.	(c)	52.	(a)	67.	(a)
8.	(c)	23.	(c)	38.	(c)	53.	(c)	68.	(c)
9.	(d)	24.	(d)	39.	(b)	54.	(c)	69.	(d)
10.	(c)	25.	(b)	40.	(b)	55.	(c)	70.	(a)
11.	(a)	26.	(a)	41.	(d)	56.	(b)	71.	(a)
12.	(a)	27.	(b)	42.	(c)	57.	(d)	72.	(c)
13.	(b)	28.	(a)	43.	(c)	58.	(c)	73.	(a)
14.	(d)	29.	(c)	44.	(a)	59.	(d)	74.	(b)
15.	(c)	30.	(c)	45.	(d)	60.	(d)	75.	(c)



IES MASTER

Institute for Engineers (IES/GATE/PSUs)

Regd. office : F-126, (Upper Basement), Katwaria Sarai, New Delhi-110016 • Phone : 011-41013406

Mob. : 8010009955, 9711853908 • E-mail: ies_master@yahoo.co.in, info@iesmaster.org

CLASS TEST [HIGHWAY] SOLUTIONS

1. (d)
2. (b)
3. (d)

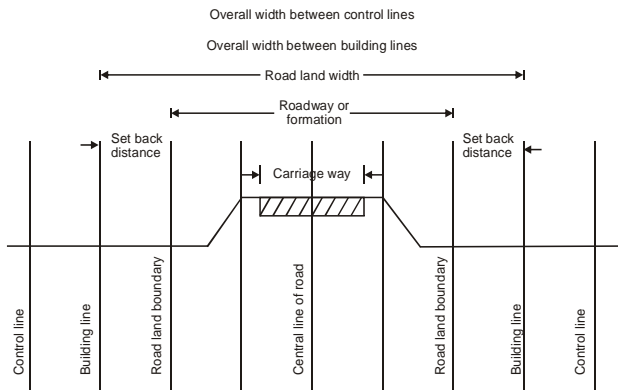

4. (b)

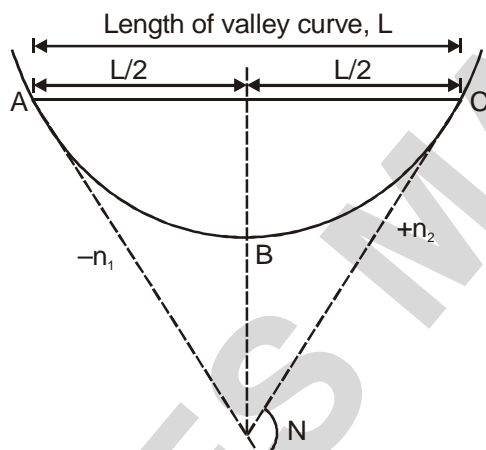

Total length of valley curve for comfort condition is given by

$$L = 0.38 (NV^3)^{1/2}$$

where N = Deviation angle in radian

V = Design speed, kmph

$$\therefore L = 0.38 \left(\frac{1}{20} \times 80^3 \right)^{1/2} = 60.8 \text{ m} \approx 61 \text{ m.}$$

5. (c)

Braking distance for travelling upgrade

$$S_1 = \frac{V^2}{254(f + 0.01n)}$$

Braking distance for travelling downgrade

$$S_2 = \frac{V^2}{254(f - 0.01n)}$$

$$S_2 = 2S_1$$

$$\frac{1}{f - 0.01n} = \frac{2}{f + 0.01n}$$

$$f + 0.01n = 2f - 0.02n$$

$$n = \frac{0.4}{0.03}$$

$$n = 13.33\%$$

6. (d)

$$L_c = 250 \text{ m}$$

$$R = 400 \text{ m}$$

Width of pavement (two lane) = 7.5 m

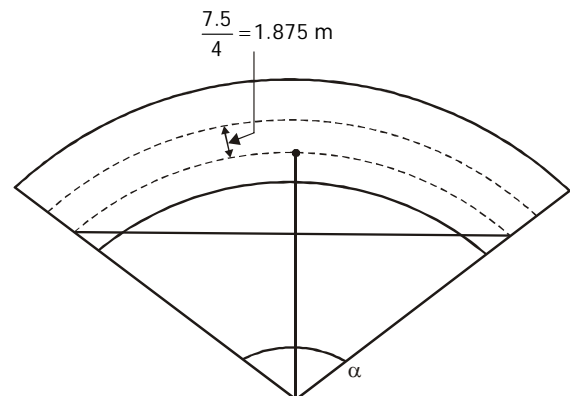

$$r = 400 - \frac{7.5}{4}$$

$$r = 400 - \frac{7.5}{4} \approx 398.125 \text{ m}$$

$$\alpha = \frac{360S}{2\pi r} = \frac{360 \times 100}{2\pi \times 398.125}$$

$$= 14.4^\circ$$

$$\frac{\alpha}{2} = 7.196^\circ$$

Set back distance from the centre line of inner



lane

$$= R - r \cos \frac{\alpha}{2}$$

$$= 400 - 398.125 \cos 7.196^\circ$$

$$= 5.01 \text{ m}$$

7. (b)

$$V = 75 \text{ kmph}$$

$$t_r = 3 \text{ sec}$$

$$n = 1/50 = 2\%$$

$$\text{S.S.D.} = 0.278 Vt + \frac{V^2}{254(f+n)}$$

$$= 0.278 \times 75 \times 3 + \frac{75^2}{254(0.40+0.02)}$$

$$\boxed{\text{S.S.D.} = 115.27 \text{ m}}$$

for single lane two way road

$$\text{S.S.D.} = 2 \times \text{S.S.D.}$$

$$\boxed{\text{S.S.D.} = 230.5 \text{ m}}$$

8. (c)

$$V = 80 \text{ kmph}$$

$$B = 3.75 \text{ m}$$

$$R = 300 \text{ m}$$

Design superelevation

$$e = \frac{V^2}{225R} = \frac{80^2}{225 \times 300} = 0.0948$$

$$e = 9.48\%$$

$$e > 7\%$$

So, provide $e_{\max} = 7\%$

from equation, $e_{\max} + f = \frac{V^2}{127R}$

$$0.07 + f = \frac{80^2}{127 \times 300}$$

$$\boxed{f = 0.09}$$

$$f < f_{\max} (0.15)$$

So, provide $e_{\max} = 7\%$

$$\tan \theta = e \approx \sin \theta = \frac{h}{B}$$

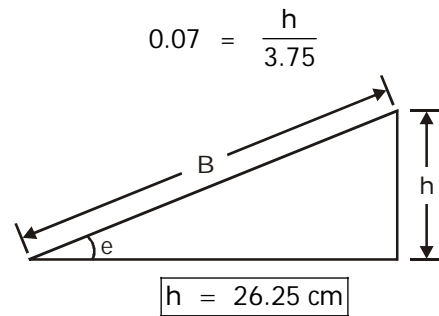

9. (d)

Hauling capacity of vehicle

$$\text{H.C.} = \mu W = 0.35 \times 4.5 \text{ tonnes}$$

$$\text{H.C.} = 1.575 \text{ tonnes}$$

$$\text{H.C.} = \text{Tractive effort (T)}$$

$$T = 1.575 \text{ t}$$

$$\theta = 14^\circ$$

Curve resistance

$$R = T (1 - \cos \theta)$$

$$R = 1.575 \times 9.81 \times (1 - \cos 14^\circ) \text{ kN}$$

$$\boxed{R = 0.458 \text{ kN}}$$

10. (c)

$$\text{Camber} = \frac{15}{450} = \frac{1}{30}$$

11. (a)

Mechanical widening

$$= \frac{l^2}{2R} = \frac{6^2}{2 \times 80} = 0.225 \text{ m}$$

Psychological widening

$$= \frac{V}{2.64\sqrt{R}} = \frac{50 \times \frac{5}{18}}{2.64 \times \sqrt{80}}$$

$$= 0.588 \text{ m.}$$

For a single lane road, only Mechanical widening is provided, hence, total widening = 0.225m.

12. (a)

13. (b)

14. (d)

15. (c)

$$\text{grade compensation} = \frac{30+300}{300} = 1.1\%$$

$$\text{max. grade compensation} = \frac{75}{300} = 0.25\%$$

$$\therefore \text{compensated grade} = 4.15 - 0.25 = 3.9\% < 4\%$$

$$\therefore \text{compensated grade} = 4\%$$

16. (b)

$$V^2 = u^2 - 2a/l$$

$$\Rightarrow 0 = u^2 - 2a/l \quad \dots(1)$$

$$\text{and } V = u - at$$

$$\Rightarrow 0 = u - at$$

$$\Rightarrow u = at \quad \dots(2)$$

$$\therefore 0 = (at)^2 - 2a/l$$

$$\Rightarrow a^2 t^2 = 2a/l$$

$$\text{and } \mu mg = ma$$

$$\Rightarrow a = \mu g$$

$$\Rightarrow \mu = \frac{2l}{t^2 g}$$

$$= \frac{2 \times 8}{3^2 \times 9.81} = 0.18.$$

17. (b)

$$T = \sqrt{\frac{4S}{a}}$$

$$S = 0.7 v_b + 6$$

$$= 0.7 \times 30 \times \frac{5}{18} + 6$$

$$= 11.83$$

$$\therefore T = 6.15 \text{ sec.}$$

18. (a)

If the road surface is kept horizontal across the alignment, the pressure on the outer wheels will be higher due to the centrifugal force acting outward and hence reaction at the outer wheel would be higher.

19. (a)

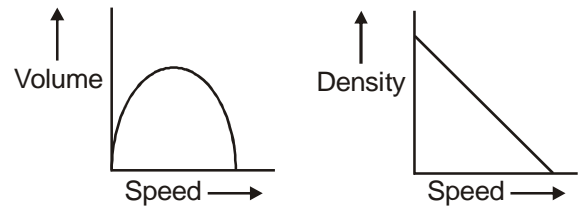

The relationships among volume-speed-density have been shown above.

20. (c)

Width of entry $e_1 = 6.5 =$ width of exit e_2

Width of weaving section (w)

$$= \left(\frac{e_1 + e_2}{2} + 3.5 \right) = 6.5 + 3.5 = 10\text{m}$$

$$\frac{W}{l} = 0.12 \text{ to } 0.4$$

For min cond.

$$\frac{W}{l} = 0.4$$

$$\text{length of weaving section} = \frac{10}{0.4} = 25 \text{ m}$$

21. (c)

Weaving ratio between N-E $P_{NE} = \frac{b+c}{a+b+c+d}$

$$a = 415, b = 650 + 300 = 950,$$

$$c = 500 + 225 = 725, d = 300$$

$$P = \frac{950 + 725}{415 + 950 + 725 + 300} = 0.70$$

22. (c)

Traffic control devices

1. Signs
2. Signals
3. Road Markings
4. Islands

Signs

(1) Regulator signs

a) Stop sign  octagonal red colour

with white border

b) Prohibitory signs



Parking prohibited No stopping or standing
Speed limit

23. (c)

Effective green time = Green time + Amber time – Total lost time

Total lost time = Initial lost time + final lost time

$$L = 3 + 2 \times 3$$

$$L = 9 \text{ sec}$$

$$G_e = 25 + 5 - 9$$

$$G_e = 21 \text{ sec}$$

24. (d)

$$A = 3200$$

$$r = 7\%$$

$$n = 10$$

$$F = 2.6$$

Number of std. axle

$$N_s = \frac{365 A [(1+r)^n - 1]}{r} \times F$$

$$N_s = 365 \times \frac{3200 [(1+0.07)^{10} - 1] \times 2.6}{0.07}$$

$$N_s = 41.957 \times 10^6 \text{ std axle}$$

$$N_s \approx 42 \text{ msa}$$

For 42 msa closest option is 710 mm

25. (b)

$$\text{Jam density} = \frac{1000}{\text{space headway}}$$

$$= \frac{1000}{7.2} \approx 139 \text{ veh/km}$$

$$\text{Maximum flow} = \frac{\text{Jam density} \times \text{free speed}}{4}$$

$$= \frac{139 \times 75}{4}$$

$$Q_{\max} = 2606 \text{ vehicles per hour}$$

26. (a)

The saturation flow rate for the approach is first computed as

$$s = \frac{3600}{2.2} = 1636 \text{ veh/h/lane}$$

The total lost time/phase for the approach is computed as

$$t_L = I_1 + I_2 = 2.0 + 1.0 = 3s$$

Next, the effective green time for the approach is computed as

$$g_i = G_i + Y_i - t_L = 37.0 + 3.5 - 3.0 = 37.5 \text{ s}$$

Finally, the capacity for the approach can be computed as follows:

$$c_i = s \frac{g_{\text{eff}}}{C}$$

$$= 1636 \times \frac{37.5}{80}$$

$$= 767 \text{ veh/h/lane}$$

Therefore, the capacity of the approach or lane group is given by multiplying the preceding figure by 2, since the approach had two lanes, as follows:

$$c = 767 \times 2 = 1534 \text{ veh/h}$$

27. (b)

28. (a)

Time t (sec)	No. of vehicles (q)	V (m/sec)	qV	q/V
2.6	11	11.53	126.83	0.954
2.8	27	10.71	289.17	2.521
3.0	62	10	620	6.2
3.4	52	8.823	458.8	5.894
Total	152		1494.8	15.57

$$\text{Time mean speed} = \frac{\sum q_i V_i}{\sum q_i} = 9.83 \text{ m/s}$$

$$\text{Space mean speed} = \frac{\sum q_i}{\sum \frac{q_i}{V_i}} = 9.762 \text{ m/s}$$



(6)

CIVIL ENGINEERING

CLASS TEST (HIGHWAY)

29. (c)

$$\begin{aligned}q_A &= 500 \text{ pcu/hr} \\q_B &= 300 \text{ pcu/hr} \\S_A &= 1600 \text{ pcu/hr} \\S_B &= 1600 \text{ pcu/hr}\end{aligned}$$

$$Y_A = \frac{q_A}{S_A} = \frac{500}{1600}$$

$$Y_B = \frac{q_B}{S_B} = \frac{300}{1600}$$

$$Y = Y_A + Y_B = \frac{800}{1600} = 0.5$$

Optimum cycle time

$$C_0 = \frac{1.5L + 5}{1 - Y}$$

$$C_0 = \frac{1.5 \times 16 + 5}{0.5}$$

$$C_0 = 58 \text{ seconds}$$

30. (c)

$$\begin{aligned}\text{Basic capacity} &= 24 \times \frac{1000}{(19 + 6)} \\&= 960 \frac{\text{vehicles}}{\text{hour}}\end{aligned}$$

31. (d)

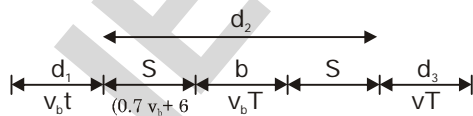

∴ overtaking sight distance

$$= d_1 + d_2 + d_3$$

$$d_1 = v_b \times t$$

where,

$$v_b = v - 4.5$$

$$= 27.78 - 4.5$$

$$= 23.28 \text{ m/s.}$$

$$v = 100 \times \frac{5}{18}$$

$$= 27.78 \text{ m/s.}$$

$$\therefore d_1 = 23.28 \times 2 \text{ sec}$$

$$= 46.56 \text{ m}$$

$$d_2 = b + 2S$$

$$\text{where, } b = v_b T$$

$$\text{and } T = \sqrt{\frac{4S}{a}}$$

$$\text{and, } S = 0.7 v_b + 6$$

$$= 0.7 \times 23.28 + 6$$

$$= 22.296 \text{ m}$$

$$\therefore T = \sqrt{\frac{4 \times 22.296}{0.53}} = 12.97 \text{ sec}$$

$$\therefore d_2 = 23.28 \times 12.97 + 2 \times 22.296$$

$$= 346.53 \text{ m}$$

$$d_3 = vT$$

$$= 27.78 \times 12.97$$

$$= 360.31 \text{ m}$$

∴ Overtaking sight distance

$$= d_1 + d_2 + d_3$$

$$= 46.56 + 346.53 + 360.31$$

$$= 753.4 \text{ m.}$$

32. (b)

For base course, t_g

$$= \left(\frac{225}{15}\right)^{1/5} \times 20 = 34.4 \text{ cm}$$

Actual pavement thickness,

$$T = 20 + 10 = 30 \text{ cm}$$

$$\text{Actual } t_g = 34.4 + 10 = 44.4 \text{ cm}$$

$$C = \left(\frac{t_g}{T}\right)^5 \times C_g = \left(\frac{44.4}{30}\right)^5 \times 15 = 106.5$$

33. (b)

$$P = \frac{\text{crossing traffic on the weaving section}}{\text{total traffic on the weaving section}}$$

$$P = \frac{1000}{2000} = 0.5$$



IES MASTER
Institute for Engineers (IES/GATE/PSUs)

Regd. office : F-126, (Upper Basement), Katwaria Sarai, New Delhi-110016 • Phone : 011-41013406

Mob. : 8010009955, 9711853908 • E-mail: ies_master@yahoo.co.in, info@iesmaster.org

$$\text{Capacity, } Q = \frac{280 \times W \times \left(1 + \frac{e}{W}\right) \left(1 - \frac{P}{3}\right)}{1 + \frac{W}{L}}$$

$$= \frac{280 \times 15 \times \left(1 + \frac{8.6}{15}\right) \left(1 - \frac{0.5}{3}\right)}{1 + \frac{15}{36}} = 3887$$

34. (c)

$q = 50$ vehicles per min

$n_a = 850$

$n_y = 320 - 250 = 70$

$t_w = 30$ min

$t_a = 35$ min

$$q = \frac{n_a + n_y}{t_a + t_w} = \frac{850 + 70}{30 + 35}$$

$$= 14.15 \text{ vehicles/min}$$

$$t = 30 - \frac{70}{14.15}$$

$$t = 25.05 \text{ min}$$

35. (a)

Basic capacity is the maximum possible capacity on the road in Ideal conditions. Two roads having same physical features will have same capacity irrespective of the traffic condition.

Traffic capacity will be maximum when time head way is minimum.

36. (a)

37. (c)

38. (c)

The problem statement provides information about the intersection: the maximum allowable speed, v ; the width of intersection, W ; the average length of vehicle, L ; the perception-reaction time, TPR ; and the deceleration rate, a .

The minimum yellow interval at this intersection is,

$$t_{\text{yellowmin}} = \frac{SSD + W + L}{v}$$

here,

$$SSD = 66 \times 2 + \frac{66^2}{2 \times 11.2} = 326.46 \text{ m}$$

$$t = \frac{326.46 + 48 + 20}{66}$$

$$t = 5.98 \text{ sec} \approx 6 \text{ sec}$$

39. (b)

Probability of arriving k number of vehicles in time t is given by

$$p(x = k/t \text{ sec}) = \frac{(\lambda t)^k e^{-\lambda t}}{k!}$$

$\lambda = 8 \text{ cars/min} = 4 \text{ cars/30 sec}$

(given)

$t = 30 \text{ sec}$

$$\therefore \lambda t = 4$$

$$P(x = 0/30 \text{ sec}) = \frac{4^0 e^{-4}}{0!} = 0.018$$

40. (b)

Required to find N such that

$$0.90 \leq P(x \leq N/30 \text{ sec})$$

Probability $P(x \leq N/30 \text{ sec})$ is given by

$$\rightarrow \sum_0^N P(x = N/30 \text{ sec})$$

$$P(x = 0/30 \text{ sec}) = 0.018$$

$$P(x = 1/30 \text{ sec}) = 0.0733$$

$$P(x = 2/30 \text{ sec}) = 0.1465$$

$$P(x = 3/30 \text{ sec}) = 0.195$$

$$P(x = 4/30 \text{ sec}) = 0.195$$

$$P(x = 5/30 \text{ sec}) = 0.156$$

$$P(x = 6/30 \text{ sec}) = 0.104$$

$$P(x = 7/30 \text{ sec}) = 0.059$$

$$P(x \leq 7/30 \text{ sec}) = \sum_{N=0}^{N=7} P(x = N/30 \text{ sec}) = 0.949$$

(i.e. > 90% hence OK)

Thus, minimum number of cars through the intersection so that the probability of this



number or fewer cars in 30 seconds is at least 90% is 7.

41. (d)

The maximum sum of critical volumes can be computed as

$$V_c = \frac{1}{h} \left[3600 - N \times t_L \times \left(\frac{3600}{C} \right) \right]$$

$$V_c = \frac{1}{2.0} \left[3600 - 3 \times 3.5 \times \left(\frac{3600}{90} \right) \right] = 1590 \text{ veh/h}$$

42. (c)

43. (c)

44. (a)

Although a number of theoretical and analytical speed density curve relationship have been published, the exact shape of the speed density curve has not been conclusively established.

45. (d)

46. (c)

47. (c)

48. (b)

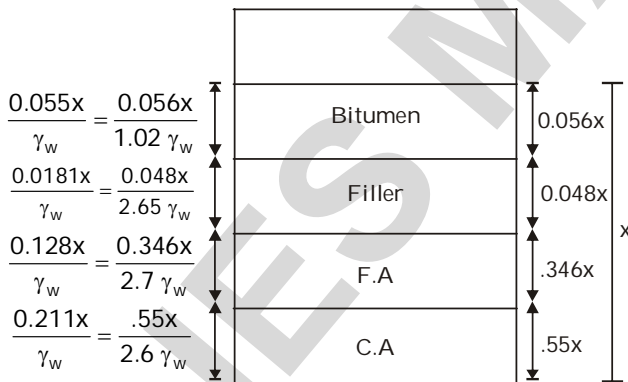

$$G_t = \frac{\gamma_t}{\gamma_w} = \frac{x}{0.412 \frac{x}{\gamma_w} \times \gamma_w} = 2.42$$

49. (d)

Pressure to cause 2.5 mm penetration
= 15 kg/cm²

Pressure to cause 5.0 mm penetration
= 20 kg/cm²

Std. pressure value

for 2.5 mm penetration

$$= 70 \text{ kg/cm}^2$$

for 5.0 mm penetration

$$= 105 \text{ kg/cm}^2$$

C.B.R. value

for 2.5 mm penetration

$$\text{CBR} = \frac{\text{Pressure to cause penetration}}{\text{std pressure}}$$

$$= \frac{15}{70} \times 100$$

$$\text{CBR} = 21.4\%$$

For 5.0 mm penetration

$$= \frac{20}{105} \times 100$$

$$\text{CBR} = 19.04\%$$

C.B.R. value is taken as maximum of both
i.e.

$$= 21.4\%$$

50. (d)

51. (b)

52. (a)

53. (c)

$$\text{Area steel req./m length} = \frac{bfhw}{100S}$$

$$= \frac{3.6 \times 1.5 \times 18 \times 2400}{100 \times 1750} = 1.333 \text{ cm}^2/\text{m}$$

$$\text{Area of one bar} = \frac{\pi(1)^2}{4} = 0.785 \text{ cm}^2$$

$$\text{Area of one bar} = 0.785 \text{ cm}^2$$

$$\text{Spacing} = \frac{0.785}{1.333} = 58.9 \text{ cm}$$

54. (c)

55. (c)



$$I = \left[\frac{Eh^3}{12k(1-\mu^2)} \right]^{1/4}$$

$$I = \left(\frac{2.1 \times 10^5 \times 15^3}{12 \times 7.5(1-0.15^2)} \right)^{1/4}$$

$$I = 53.3 \text{ cm}$$

Equivalent radius of resisting section

$$b = \sqrt{1.6a^2 + h^2} - 0.675h$$

If $a < 1.72h$

$$b = \sqrt{1.6 \times 15^2 + 15^2} - 0.675 \times 15$$

$$b = 14.06 \text{ cm}$$

56. (b)

$$\text{CBR} = 8\%$$

$$P = 4200 \text{ Kg}$$

$$p = 6 \text{ Kg/cm}^2$$

Total thickness of pavement,

$$t = \sqrt{P} \left[\frac{1.75}{\text{CBR}} - \frac{1}{p\pi} \right]^{1/2}$$

$$t = \sqrt{4200} \left[\frac{1.75}{8} - \frac{1}{6 \times 3.14} \right]^{1/2}$$

$$t = 26.37 \text{ cm}$$

57. (d)

58. (c)

$$a_1 = 30 \text{ cm}$$

$$\Delta = 0.125 \text{ cm}$$

$$p = 0.84 \text{ kg/cm}^2$$

modulus of subgrade reaction corresponding to plate size 30 cm

$$k_1 = \frac{p}{\Delta} = \frac{0.84}{0.125} = 6.72 \text{ kg/cm}^3$$

modulus of subgrade reaction is calculated corresponding to plate of size 75 cm.

correction for smaller sized plate,

$$k_1 a_1 = k_2 a_2$$

$$6.72 \times 30 = k_2 \times 75$$

$$k_2 = 2.68 \text{ kg/cm}^3$$

59. (d)

60. (d)

61. (c)

The value of superelevation needed increases with increase in speed and with decrease in radius of the curve, for a constant value of coefficient of lateral friction, f . From the practical view point, it will be necessary to limit the maximum allowable superelevation to avoid very high values of 'e'. This is particularly necessary when the road has to cater for mixed traffic consisting of fast and slow traffic. A skillful highway designer builds in speed control at critical locations on horizontal curves rather to increase the superelevation. A driver slows down on horizontal curve due to feeling of discomfort because of increase in centrifugal force.

62. (b)

63. (d)

A transition curve introduced between the tangent and the circular curve should fulfil the following conditions :

1. It should be tangential to the straight.
2. It should meet the circular curve tangentially
3. Its curvature should be zero at the origin on straight.
4. Its curvature at the junction with the circular curve should be the same as that of the circular curve.
5. Its length should be such that full cant or super elevation is attained at the junction with the circular curve.

64. (d)

65. (c)

The cant provided by raising the outer edge of the pavement with inner edge forming the

pivot point is to avoid drainage problem. In this case vertical alignment of the road is altered and centre line also get damaged.

66. (d)

IRC suggests following procedure for design of superelevation

(i) Find e (superelevation) for 75% of design speed neglecting friction

$$e = \frac{(0.75V)^2}{gR}$$

(ii) If e is less than 7% (0.07) then it is provided. If $e > 7\%$ then we follow next steps

(iii) Find coefficient of friction for maximum $e = 0.07$ with full design speed

$$f = \frac{V^2}{gR} - 0.07$$

If $f < 0.15$ then $e = 0.07$ is safe for design speed else,

(iv) Alternative speed is found using max. value of coefficient of friction and maximum superelevation

$$\frac{V_a^2}{gR} = 0.15 + 0.07$$

$$V_a = \sqrt{0.22gR}$$

If allowable speed is greater than design speed the design is adequate. If allowable speed is less than design speed, the speed is limited to allowable speed and warning sign, speed regulations signs are installed.

So, Assertion is wrong as per step (i) and Reason is correct as per step (iv)

67. (a)

68. (c)

69. (d)

70. (a)

71. (a)

72. (c)

Ties bars are provided at longitudinal joints in cement concrete slabs. Tie bars are not designed as load transfer device but ensures that two slabs remain firmly together. Load is actually transferred to the adjacent slab due to aggregate interlock.

73. (a)

74. (b)

75. (c)

